

Assembly Instructions -Model 300x / 400x

The following instructions are to complete the assembly of your Manco Fun Kart using the component parts and hardware that were packaged with the kart. Carefully read these instructions completely before starting the assembly.

Tools required for assembly

- (2) 9/16" Wrench
- (2) 3/4" Wrench
- (1) 3/8" Wrench
- (1) Side Cutter



Warning: Risk of death or Bodily Injury. The overhead and center bars and the shoulder belt are critical parts of the Operator / Passenger safety system on this kart. Do not attempt to operate the kart until these components have been properly installed.

Bar Assembly

Position the center bar & rack assembly on the frame using four 3/8"-16 x 3.50" bolts (PN 2386) and four 3/8" nuts (PN 9085) to hold it in place. Do not tighten these fasteners completely at this time.

Position the over head bar assembly on the kart using two 3/8"-16 x 3.50" bolts (PN 2386) at the top bushings and install two 3/8" nuts (PN 9085). Do not tighten these fasteners completely at this time. Install two 3/8"-16 x 3.50" bolts (PN 2386) at the front bushings and install two 3/8" nuts

(PN 9085). Do not tighten these fasteners at this time. Fully tighten all of the overhead bar and center bar mounting bolts at this time. These fasteners use locking nuts and require a high level of torque to be applied to tighten them securely.

Headrest Pad Assembly

Assemble each headrest pad to the headrest frame using two 1/4"-20 x 1/2" bolts (PN 9006) per headrest.

Seat

Fold the seat back against the seat frame and fasten using two 1/4"-20 x 1/2" bolts (PN 9006).

Shoulder Belt Assembly

Position the shoulder belt mounting tab against the support tab on the center bar and rack assembly placing a 1/2" washer (PN 9022) between the tab and the shoulder belt. Use a 1/2"-13 x 1.50" bolt (PN 9188) and 1/2" nut (PN 1012) to secure the seat belt bracket. Tighten the bolt and nut until the bracket and tab make contact with the washer between them but do not over tighten. When properly assembled, the belt bracket should be able to rotate freely on the mounting bolt. Follow this process for both the Operator and Passenger belts.

Safety Flag Assembly

Insert the flag shaft through the flag mounting bolt (PN 11361)

installed in the mounting tab on the rear loop of the frame. Place one washer (PN 9022) between the bolt head and the flag mounting bracket. Allow approximately 1/2" of the shaft to protrude past the end of the bolt. Use wrenches to securely tighten the nut (PN 1012) and bolt to fix the position of the flag

Engine Fluids

Read and follow instructions in the engine manual.

Remove oil fill plug and fill the engine crankcase with 20 oz of 30W type SF or higher motor oil. Replace and securely tighten the oil fill plug.

Fill the fuel tank with regular grade clean, unleaded gasoline. Do not use premium grade gasoline, gasohol or diesel fuel.

13796S0

CENTER BAR &
RACK

PROPER SHOULDER
BELT ASSEMBLY

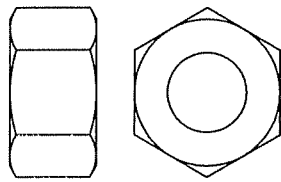
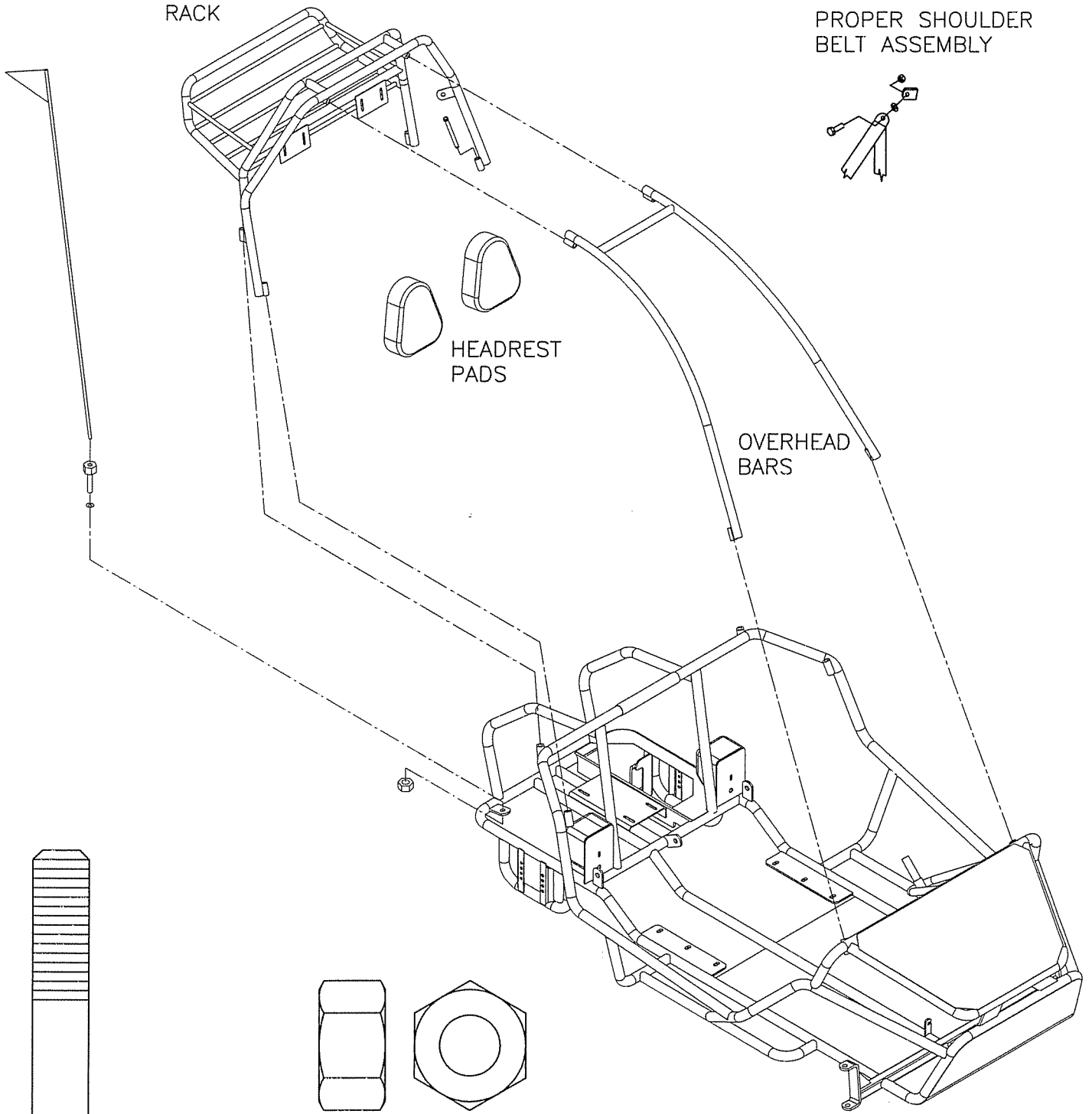

1012
QTY (3)

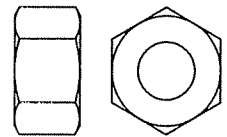

9085
QTY (8)

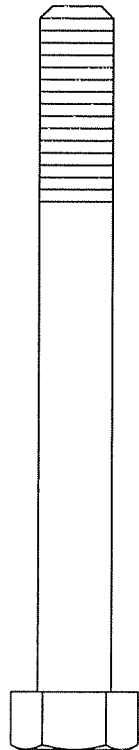

2386
QTY (8)

3/8-16 X 3.500

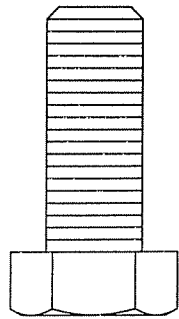

9188
QTY (2)

1/2-13 X 1.50

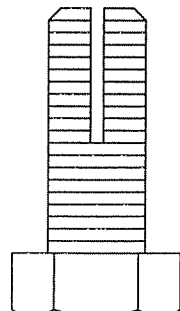

11361
QTY (1)

1/2-13 X 1.50

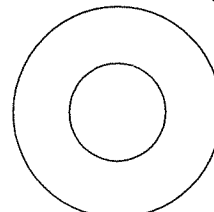

9022
QTY (3)

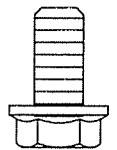

9006
QTY (6)

1/4-20 X .500